

IWASE
EXLON Series

To become a company that becomes useful for our customers with tubing.

EXLON Tubing of Iwase is being supported by our customers and used in a variety of applications, such as electric devices, automobile, OA, semiconductor, and physics and chemistry. We are committed to keep working toward improving functions and quality of the product, of course, and our delivery systems, quality management systems, and environmental measures so that our customers can use our products with trust.

We appreciate your continuous support and loyalty to Iwase's EXLON Tubing.

IWASE

INDEX

EXLON PVC Series

EXLON-PVC UL Tubing	P4
EXLON-PVC AH105 Tubing	P6
EXLON-PVC J Tubing	P8
EXLON-PVC AH125 Tubing	P10
EXLON-PVC Non-migration Tubing	P12
EXLON-PVC Soft Tubing	P14
EXLON Flexible PVC Hose	P16

EXLON eco Series

EXLON- Flow-Link Tubing NHX-125	P20
EXLON- Flow-Link Tubing NHX-105	P22
EXLON- Soft-Eco Tubing NHR-80	P24
EXLON-LINK Tubing	P26
EXLON- Eco Clear Tubing	P28







EXLON Fluoro Resin Series

EXLON PFA Tubing	P32
EXLON PFA Micro-Fluoro Resin Tubing	P34
EXLON PFA Flexible Tubing	P36
EXLON PFA Coil Tubing	P38
EXLON THV Soft Fluoro Resin Tubing	P40
The lineup of modified PFA Tubing	P42
Data of EXLON-PFA Tubing	P44
Data of EXLON-THV Soft Fluoro Resin Tubing	P46
Characteristics of Fluoro Resin	P48











Standards

-  UL224, C22.2 Standard approval is acquired.
-  UL224, C22.2 Standard approval for non-flammability is acquired.







Environmental aspects

-  The same level of flexibility as PVC is achieved despite the use of eco-friendly materials.
-  Material recycling
-  Transparency is achieved using eco-friendly materials.
-  Resistance such as against varnishing This results in improved workability.
-  Low smoke emission level is achieved for the combustion gas.
-  This product has high resistance to repeated flexing.

Highly heat resistant

-  The highest heat resistant temperature
-  This product has excellent electric insulation property.
-  Extra fine Tube with the inner diameter of 0.1 mm is realized.
-  This product remains inactive when exposed to various chemicals.
-  The amount of elution is small.
-  This product can be used in movable sections.
-  This product is resistant to the effects of the environment.
-  The use of fluorine materials realized transparency.
-  This product can be bent in any forms.
-  The surface of this product is smooth.
-  This product has excellent flexibility compared to ordinary PFA.

Special aspects

-  This product has self-extinguishing characteristics.
-  This product is highly nonflammable.
-  This product is resistant to corrosion upon coming into contact with other products made of resin.
-  Recommended uses The highest heat resistant temperature 60°C level
-  This product is flexible and suitable for the low-temperature environment.
-  This product is flexible, resistant to the low temperature environment, and heat resistant.

EXLON
PVC
Series

PVC UL Tubing

PVC AH105 Tubing

PVC J Tubing

PVC AH125 Tubing

PVC Non-migration Tubing

PVC Soft Tubing

Flexible PVC Hose

EXLON PVC Series

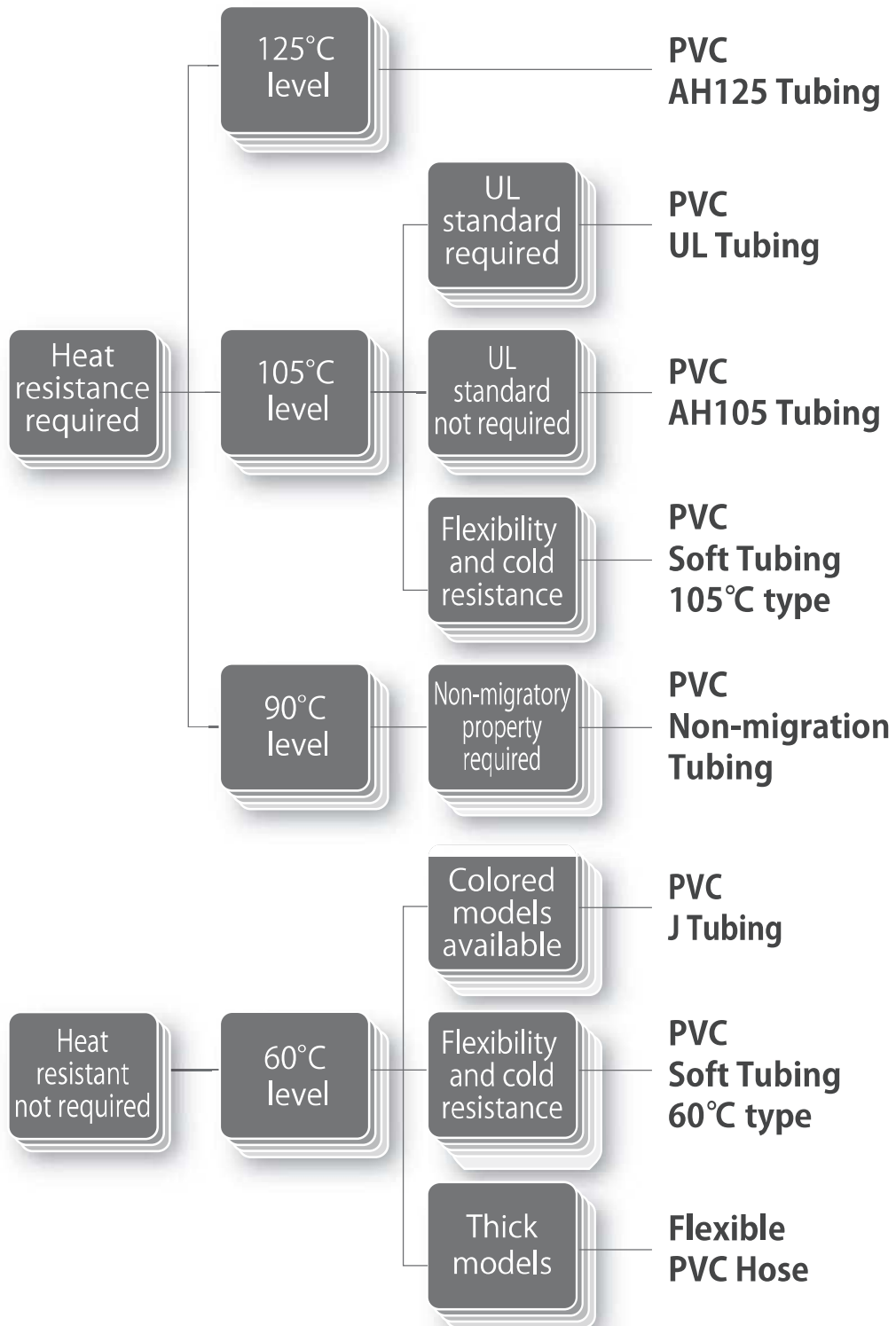

EXLON-PVC Series

EXLON-PVC UL Tubing



Printing on the tubing For 300 V **○-F-** E56036 IWASE AH-3 CSA PVC 105C VW-1

For 600 V **○-F-** E56036 IWASE AH-6 CSA PVC 105C VW-1



EXLON-PVC UL tubing designed for electric insulation are produced based on UL standards and CSA standards and have excellent heat resistance, non-flammability and environmental resistance.

Details of standards that the UL Tubing complies with

Category	UL224	CSA C22.2	Electrical Appliance and Material Safety Act
Certification number	E 56036	LR 33763	—
Temperature rating	105°C		—
Voltage rating	300V (AH-3) • 600V (AH-6)		—
Flammability rating	VW-1		-F-

Table of tubing characteristics

Items	Standard value(UL/CSA)	Performance value	Test method and other aspects	
Tensile strength (MPa)	10.4 or more	17.0 or more		
Extension (%)	100 or more	250 or more		
Dielectric strength	2,500 V 1 minute or more	10,000 V 1 minute or more	136°C 7 days	
After heat aging	Tensile strength	7.4 MPa or more		15.0 MPa or more
	Elongation(%)	100% or more		200% or more
	Dielectric voltage	2,500 V 1 minute or more		10,000 V 1 minute or more
	Copper stability	Elongation 100% or more		Elongation 200% or more
Flexibility	No crack or permanent deformation	No abnormality		
Volume resistivity	10 ¹⁰ Ω-cm or more	10 ¹² Ω-cm or more		
Flammability	VW-1	VW-1		
Cold bend	No crack	No crack	-30°C 1 hour	
Longitudinal change (%)	±5	4.0 or less	100°C 2 hours	

* The data above are representative values and not guaranteed values.

* Recommended temperature range: -20°C to 105°C

EXLON-PVC UL Tubing



Standard size chart						
Size	Inner diameter (mm)	Inner diameter tolerance (mm)	Standard wall(thickness) (mm)		Unit length (m)	
			AH-6 (600V)	AH-3 (300V)		
AWG 24	0.55	±0.1	0.60	0.40	300	
22	0.65	±0.1	0.60	0.40	300	
20	0.85	±0.1	0.60	0.40	300	
19	0.9	±0.1	0.60	0.40	300	
18	1.0	±0.15	0.60	0.40	300	
17	1.2	±0.15	0.62	0.40	300	
16	1.3	±0.15	0.62	0.40	300	
15	1.5	±0.15	0.62	0.40	300	
14	1.7	±0.15	0.62	0.40	300	
13	1.9	±0.2	0.62	0.40	300	
12	2.1	±0.2	0.62	0.40	300	
11	2.4	±0.2	0.62	0.40	300	
10	2.7	±0.2	0.62	0.50	300	
9	3.0	±0.25	0.62	0.50	300	
8	3.3	±0.25	0.62	0.50	300	
7	3.7	±0.25	0.62	0.50	300	
6	4.2	±0.3	0.62	0.50	300	
5	4.7	±0.3	0.62	0.50	300	
4	5.3	±0.3	0.62	0.50	300	
3	5.9	±0.3	0.62	0.50	300	
2	6.6	±0.3	0.62	0.50	200	
1	7.4	±0.35	0.62	0.50	200	
0	8.3	±0.35	0.62	0.50	200	
5/16"	8.0	±0.35	0.62		200	
6/16"	9.5	±0.35	0.62		200	
7/16"	11.1	±0.35	0.68		200	
8/16"	12.7	±0.35	0.68		200	
9/16"	14.3	±0.4	0.80		100	
10/16"	16.0	±0.4	0.80		100	
12/16"	19.0	±0.4	0.90		100	
14/16"	22.0	+0.7、-0.5	0.90		50	
16/16"	25.0	+0.7、-0.5	0.90		50	
1-1/16"	27.0	+0.7、-0.5	1.00		50	
1-1/4"	32.0	+1.0、-0.5	1.05		50	
1-1/2"	38.0	+1.0、-0.5	1.20		50	
1-3/4"	44.0	+1.5、-1.0	1.40		50	
16/8"	50.0	+1.5、-1.0	1.50		50	

- Transparent/Black is the standard color for the tubing. Other colors (red, blue, yellow, gray, brown, white, green, and orange) can be produced when orders are received.
- We also welcome orders for tubes with other colors, special sizes, and pipes cut in various lengths.



EXLON-PVC
UL Tubing

Acquired

Acquired

EXLON-PVC Series

EXLON-PVC AH 105 Tubing



Printing on the tubing **AH 105**

Characteristics

EXLON-PVC AH105 Tubing is produced using the same materials as EXLON-PVC UL Tubing that complies with Iwase's UL and CSA Standards. These tubing have extremely excellent heat resistance, electric properties, non-flammability, and other performances.

Purposes

- (i) For providing heat resistance, insulation, and protection of wires of electronic and electric devices.
- (ii) For protecting lead wires of transformers, magnet coils, condensers, and other devices.

Table of tubing characteristics				
Items	Standard value	Performance value	Testing conditions and other aspects	
Tensile strength (MPa)	10.4 or more	17.0 or more		
Extension (%)	100 or more	250 or more		
Dielectric strength	2,500 V 1 minute or more	10,000 V 1 minute or more		
After heat aging	Tensile strength	7.4 MPa or more	136°C 7 days	
	Elongation(%)	100% or more		
	Dielectric voltage	2,500 V 1 minute or more		
	Copper stability	Extension 100% or more		Extension 200% or more
	Flexibility	No crack or permanent deformation		No abnormality
Volume resistivity	10 ¹⁰ Ω-cm or more	10 ¹² Ω-cm or more		
Flammability	VW-1	Equivalent of VW-1		
Cold bend	No crack	No crack	-30°C 1 hour	
Longitudinal change (%)	±5	5.0 or less	100°C 2 hours	

* The data above are representative values and not guaranteed values.

* Properties are the same level as UL Tubing.

* Recommended temperature range: -20°C to 105°C

EXLON-PVC AH105 Tubing



Standard size chart					
Size	Inner diameter (mm)	Inner diameter tolerance (mm)	Wall thickness (mm)	Thickness tolerance (mm)	Unit length (m)
1.5 × 2.3	1.5	+0.2、-0.1	0.4	±0.08	300
2 × 2.8	2.0	+0.2、-0.1	0.4	±0.08	300
2.5 × 3.5	2.5	+0.3、-0.2	0.5	+0.1、-0.08	300
3 × 4	3.0	+0.3、-0.2	0.5	+0.1、-0.08	300
3.5 × 4.5	3.5	+0.3、-0.2	0.5	+0.1、-0.08	300
4 × 5	4.0	+0.3、-0.2	0.5	+0.1、-0.08	300
4.5 × 5.5	4.5	+0.3、-0.2	0.5	+0.1、-0.08	300
5 × 6	5.0	+0.3、-0.2	0.5	+0.1、-0.08	Transparent 300/Black 400
6 × 7	6.0	+0.4、-0.2	0.5	+0.1、-0.08	Transparent 300/Black 400
7 × 8	7.0	+0.4、-0.2	0.5	+0.1、-0.08	300
8 × 9	8.0	+0.4、-0.2	0.5	+0.1、-0.08	300
9 × 10	9.0	+0.4、-0.2	0.5	+0.1、-0.08	200
10 × 11.2	10.0	+0.4、-0.2	0.6	±0.1	200
12 × 13.2	12.0	+0.5、-0.3	0.6	±0.1	200

- Transparent/Black is the standard color for the tubing. Other colors (red, blue, yellow, gray, brown, white, green, and orange) can be produced when orders are received.
- We also welcome orders for tubing with other colors, special sizes, and pipes cut in various lengths.
- Printing on the tubing range from 2.5Ø to 16Ø.



Colored models available

EXLON-PVC
AH105 Tubing



Highly nonflammable



105°C level

EXLON-PVC Series

EXLON-PVC J Tubing



Characteristics

EXLON-PVC J Tubing is equivalent of EX PVC1, which complies with the old standard JIS C 2415. These multipurpose vinyl tubing are designed with a good balance of properties, including electric insulation property, non-flammability, and flexibility.

Purposes

- (i) For providing electric insulation for devices and equipment, such as electronic devices, electric devices, measuring instruments, and communication devices.
- (ii) For providing mechanical protection for or as identification of electric wires and devices.

Table of tubing characteristics					
Items		Unit	Standard value	Performance value	Test method and other aspects
Tension test	Tensile strength	MPa	10.4 or more	15.0 or more	JIS C 2133
	Elongation	%	100 or more	200 or more	
Dielectric strength		—	Nondestructive	Nondestructive	2,500V × 1 minute
Cold bend		—	No crack	No crack	-10° C × 1 hour
Longitudinal change		%	-10 or more	-10 or more	120° C × 1 hour
Volume resistivity		Ω/m	10 ⁸ or more	10 ¹⁰ or more	JIS C 2133

* The data above are representative values and not guaranteed values.

* Recommended temperature range: -20°C to 60°C

EXLON-PVC J Tubing



Standard size chart					Standard size chart				
Inner diameter (mm)	Thickness (mm)	Tolerance		Unit length (m)	Inner diameter (mm)	Thickness (mm)	Tolerance		Unit length (m)
		Inner diameter (mm)	Thickness (mm)				Inner diameter (mm)	Thickness (mm)	
0.5	0.35	±0.1	±0.08	500	10.0	0.5	+0.4、-0.2	+0.1、-0.08	250
0.8	0.35	±0.1	±0.08	500	11.0	0.5	+0.5、-0.3	+0.1、-0.08	200
1.0	0.4	±0.1	±0.08	500	12.0	0.5	+0.5、-0.3	+0.1、-0.08	200
1.2	0.4	±0.1	±0.08	500	13.0	0.5	+0.5、-0.3	+0.1、-0.08	200
1.5	0.4	±0.1	±0.08	500	14.0	0.5	+0.5、-0.3	+0.1、-0.08	200
2.0	0.4	±0.2	±0.08	500	15.0	0.5	+0.5、-0.3	+0.1、-0.08	200
2.5	0.4	±0.2	±0.08	400	16.0	0.6	+1.0、-0.8	±0.1	100
3.0	0.5	±0.2	+0.1、-0.08	400	18.0	0.6	+1.0、-0.8	±0.1	100
3.5	0.5	±0.2	+0.1、-0.08	400	20.0	0.8	+1.0、-0.8	±0.1	50
4.0	0.5	+0.3、-0.2	+0.1、-0.08	400	22.0	0.8	±1.5	±0.1	50
4.5	0.5	+0.3、-0.2	+0.1、-0.08	400	25.0	0.8	±1.5	±0.1	50
5.0	0.5	+0.3、-0.2	+0.1、-0.08	400	30.0	1.0	±1.5	±0.1	50
5.5	0.5	+0.3、-0.2	+0.1、-0.08	400	35.0	1.0	±1.5	±0.1	50
6.0	0.5	+0.4、-0.2	+0.1、-0.08	400	40.0	1.0	±1.5	±0.1	50
7.0	0.5	+0.4、-0.2	+0.1、-0.08	300	45.0	1.0	±1.5	±0.1	50
8.0	0.5	+0.4、-0.2	+0.1、-0.08	300	50.0	1.0	±1.5	±0.1	50
9.0	0.5	+0.4、-0.2	+0.1、-0.08	300					

- Transparent/Black is the standard color for the tubing. Other colors (red, blue, yellow, gray, brown, white, green, and orange) can be produced when orders are received.
- We also welcome orders for tubing with other colors, special sizes, and pipes cut in various lengths.
- Sizes 16ø or large come with flattened shapes.



EXLON-PVC
J Tubing



EXLON-PVC Series

EXLON-PVC AH125 Tubing



Printing on the tubing **IWASE AH125 PVC**

Characteristics

EXLON-PVC AH125 Tubing is have the highest heat resistance and resistance to aging (125°C level) among Iwase's PVC series. These are high-level vinyl tubing designed for electric insulation with excellent properties, such as electric insulation properties, friction resistance, thermal deformation resistance, and non-flammability.

Purposes

These products are expected to be used in the high-temperature operating environment.

- (i) For providing heat resistance, insulation, and protection of wires of electronic and electric devices.
- (ii) For protecting lead wires of transformers, magnet coils, condensers, and other devices.

Table of tubing characteristics					
Items		Unit	Standard value	Performance value	Test method and other aspects
Tension test	Tensile strength	MPa	10.4 or more	15.0 or more	JIS C 2133
	Elongation	%	100 or more	200 or more	
After heat aging	Tensile strength retention rate	%	70 or more	80 or more	158°C × 7 days
	Elongation retention rate	%	70 or more	80 or more	
Dielectric strength		—	Nondestructive	Nondestructive	2,500 V × 1 minute
Cold bend		—	No crack	No crack	-10°C × 1 hour
Longitudinal change		%	5 or less	5 or less	100°C × 2 hours

* The data above are representative values and not guaranteed values.

* Recommended temperature range: -20°C to 125°C

EXLON-PVC AH125 Tubing



Standard size chart					
Size	Inner diameter (mm)	Inner diameter tolerance (mm)	Wall thickness (mm)	Thickness tolerance (mm)	Unit length (m)
4×5	4.0	+0.3、-0.2	0.5	±0.1	300
5×6	5.0	+0.3、-0.2	0.5	±0.1	300
6×7	6.0	+0.3、-0.2	0.5	±0.1	300
7×8	7.0	+0.4、-0.2	0.5	±0.1	300
8×9	8.0	+0.4、-0.2	0.5	±0.1	300
9×10	9.0	+0.4、-0.2	0.5	±0.1	200
10×11.2	10.0	+0.4、-0.2	0.6	±0.1	200

- The standard color for the tubing is black, and tubing are produced based on orders.
- We welcome orders for special sizes and tubing cut in various lengths.

EXLON-PVC
AH125 Tubing



Self-extinguishing
property



125°C level

EXLON-PVC Series

EXLON-PVC Non-migration Tubing

IWASE



Printing on the tubing ○ タイ・スチロール△ヨウ



These are flexible PVC tubing made with special polymer plasticizer and have excellent non-migratory property, oil resistance, and heat resistance. The migration of plasticizer, which is one of the faults of ordinary flexible PVC, is extremely small in these tubing. They would not damage or deform surfaces of other mold cast resin products, such as housing when they come in contact with them.

Data of non-migratory property

Tubing name	On styrene	On ABS	On PP	On acrylic	On polycarbonate
Non-migration Tubing	○	○	◎	◎	○

Table of tubing characteristics

Items		Unit	Standard value	Performance value	Test method and other aspects
Tension test	Tensile strength	MPa	10.4 or more	15.0 or more	JIS C 2133
	Elongation	%	100 or more	200 or more	
After heat aging	Tensile strength retention rate	%	70 or more	80 or more	121°C × 7 days
	Elongation retention rate	%	70 or more	80 or more	
Dielectric strength		—	Non destructive	Non destructive	2,500V × 1 minute
Cold bend		—	No crack	No crack	-10°C × 1 hour
Longitudinal change		%	5 or less	5 or less	100°C × 2 hours

* The data above are representative values and not guaranteed values.

* Recommended temperature range: -20°C to 90°C

EXLON-PVC Non-migration Tubing



Standard size chart					
Size	Inner diameter (mm)	Inner diameter tolerance (mm)	Wall thickness (mm)	Thickness tolerance (mm)	Unit length (m)
4×5	4.0	+0.3、-0.2	0.5	±0.1	300
5×6	5.0	+0.3、-0.2	0.5	±0.1	300
6×7	6.0	+0.4、-0.2	0.5	±0.1	300
7×8	7.0	+0.4、-0.2	0.5	±0.1	300
8×9	8.0	+0.4、-0.2	0.5	±0.1	300
9×10	9.0	+0.4、-0.2	0.5	±0.1	200
10×11	10.0	+0.4、-0.2	0.5	±0.1	200

- Transparent and black are the standard colors of these tubing.
- We also welcome orders for tubing with other colors, special sizes, and tubing cut in various lengths.
- We also welcome orders for thick models.

EXLON-PVC
Non-migration Tubing



Non-migratory



90°C level



Self-extinguishing
characteristics

EXLON-PVC Series

EXLON-PVC Soft Tubing



The use of special PVC in the resin provides great flexibility and elasticity. Heat resistant tubing with 105°C level and excellent heat resistance in the high temperature range are also available besides the generation type with 60°C level.



These tubing are suitable for wiring in narrow areas where flexibility is required, areas where wires are bent, and the low temperature environment.

Table of tubing characteristics					
Items		Unit	60°C type	105°C type	Test method and other aspects
Tension test	Tensile strength	MPa	12.0 or more	15.0 or more	JIS C 2133
	Elongation	%	250 or more	250 or more	
After heat aging	Tensile strength retention rate	%	70 or more	90 or more	100°C × 5 days
	Elongation retention rate	%	70 or more	90 or more	
After heat aging	Tensile strength retention rate	%	—	70 or more	136°C × 7 days
	Elongation retention rate	%	—	70 or more	
Cold bend		—	No crack	No crack	-40°C × 1 hour
Longitudinal change		%	5 or less	5 or less	100°C × 2 hours

* The data above are representative values and not guaranteed values.

* Recommended temperature range: 60°C type -30°C to 60°C

105°C type -30°C to 105°C

EXLON-PVC Soft Tubing



Standard size chart					
Size	Inner diameter (mm)	Inner diameter tolerance (mm)	Wall thickness (mm)	Thickness tolerance (mm)	Unit length (m)
4×5	4.0	+0.3、-0.2	0.5	±0.1	300
5×6	5.0	+0.3、-0.2	0.5	±0.1	300
6×7	6.0	+0.4、-0.2	0.5	±0.1	300
7×8	7.0	+0.4、-0.2	0.5	±0.1	300
8×9	8.0	+0.4、-0.2	0.5	±0.1	200
9×10	9.0	+0.4、-0.2	0.5	±0.1	200
10×11	10.0	+0.4、-0.2	0.5	±0.1	200
12×13	12.0	+0.5、-0.3	0.5	±0.1	200
14×15.2	14.0	+0.5、-0.3	0.6	±0.1	100
16×17.2	16.0	+1.0、-0.8	0.6	±0.1	100
18×19.2	18.0	+1.0、-0.8	0.6	±0.1	100
20×21.6	20.0	+1.0、-0.8	0.8	±0.1	100

- The standard color for the tubing is black, and tubing are produced based on orders.
- We also welcome orders for other colors, special sizes, and tubing cut in various lengths.
- We also welcome orders for highly nonflammable tubing with excellent non-flammability (UL94V-0 grade).

EXLON-PVC
Soft Tubing



60°C type



105°C type



Flexibility



Self-extinguishing
characteristics

EXLON-PVC Series

EXLON Flexible PVC Hose



Highly flexible PVC resin is used in the material, and thick tubing have great flexibility.



The great flexibility makes these tubing suitable as air tubing and wastewater pipes in narrow areas.

Table of tubing characteristics				
Items		Unit	Standard value	Test method and other aspects
Tension test	Tensile strength		N/mm ²	13.7 or more
	Elongation		%	200 or more
Heat aging test	Tensile strength change rate		%	±20
	Elongation change rate		%	±20
Cold resistance test			—	No crack occurs.
Immersion test	Water	Water absorption rate	%	0.5 or less
		Extraction rate	%	0.5 or less
	Saline solution		%	±0.5
	Sulfuric acid		%	±0.5
	Nitric acid		%	±5
	Sodium hydroxide solution		%	±5

* The data above are representative values and not guaranteed values.

* Recommended temperature range: -20°C to 60°C

EXLON Flexible PVC Hose



Standard size chart					
Size	Inner diameter (mm)	Inner diameter tolerance (mm)	Wall thickness (mm)	Thickness tolerance (mm)	Unit length (m)
4×6	4.0	±0.3	1.0	±0.2	300
5×7	5.0	±0.3	1.0	±0.2	300
6×8	6.0	±0.4	1.0	±0.2	300
7×9	7.0	±0.4	1.0	±0.2	300
8×10	8.0	±0.4	1.0	±0.2	200
9×11	9.0	±0.4	1.0	±0.2	200
10×12	10.0	±0.4	1.0	±0.2	200
12×14	12.0	±0.5	1.0	±0.2	200
13×15	13.0	±0.5	1.0	±0.2	100
14×16	14.0	±0.5	1.0	±0.2	100
15×17	15.0	±0.5	1.0	±0.2	100

- Transparent and black are the standard colors of these tubings.
- We also welcome orders for tubing with other colors, special sizes, and tubing cut in various lengths.
- We also welcome orders for thick models.

EXLON
Flexible PVC Hose



Free pipe arrangement



Flexibility



60°C level



Self-extinguishing characteristics

EXLON
eco
Series

Flow-Link Tubing NHX-125

Flow-Link Tubing NHX-105

Soft-Eco Tubing NHR-80

LINK Tubing

Eco Clear Tubing

EXLON eco Series

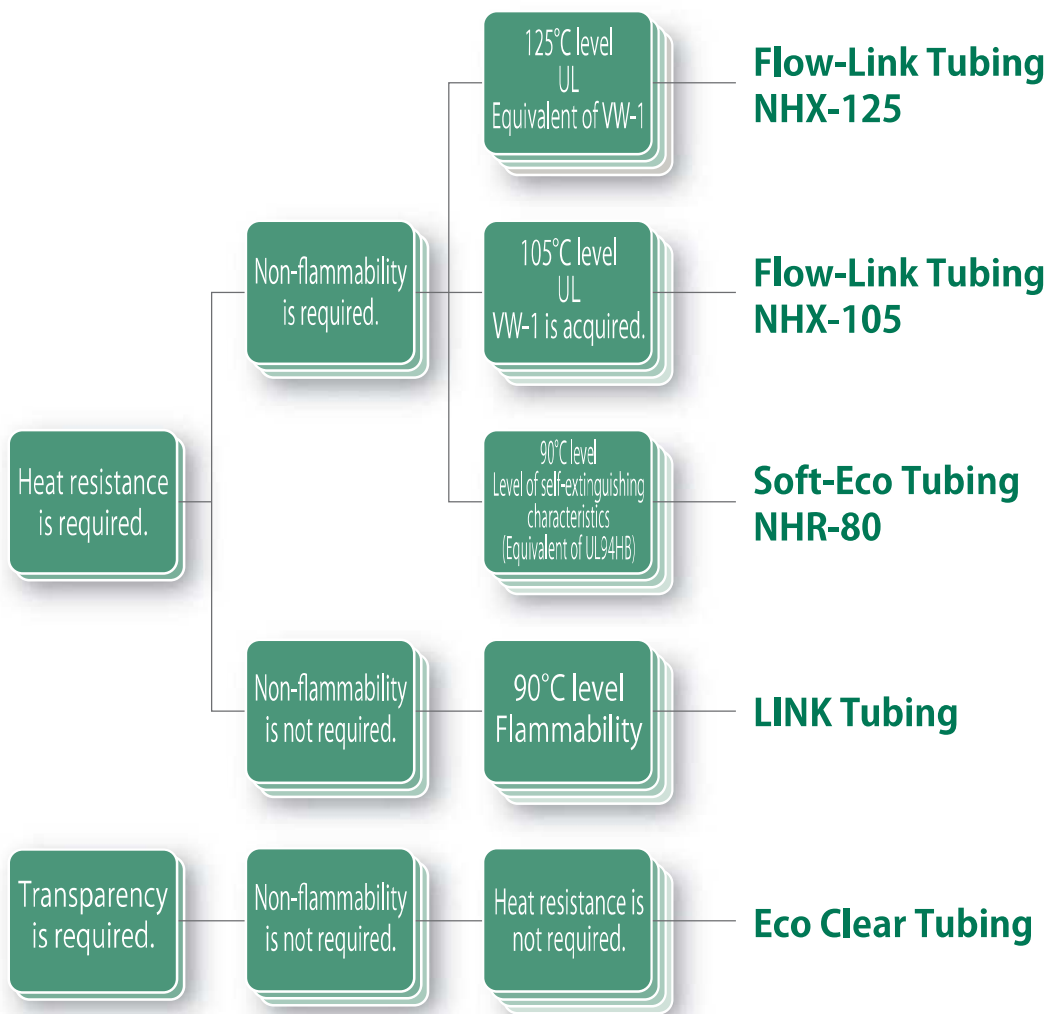

EXLON-eco Series

EXLON-Flow-Link Tubing NHX-125

IWASE



Printing on the tubing **IWASE EXLON NHX-125**



This is a clean, highly nonflammable, highly heat resistant, and flexible, completely new type of elastomer tubing with environmental conservation features.

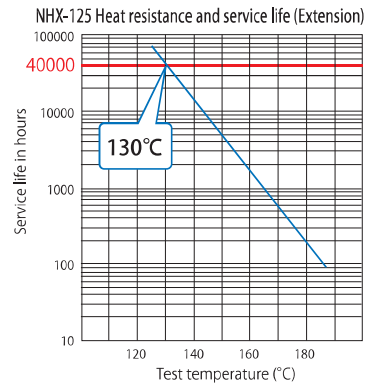

Highly nonflammable

High non-flammability

Equivalent of VW-1 based on the UL Standard



Flexibility

Flexibility

The workability of the harness is drastically improved with the great flexibility that is not seen in conventional polyethylene tubing with electron beam crosslinking.



125°C level

125°C level

The polymer has unique partial crosslinking structure inside, and the long-term heat resistance is at the 125°C level.



Recyclability

Recycling

Materials can be recycled like a general thermo plastics.

EXLON-Flow-Link Tubing NHX-125



Table of tubing characteristics			
Items	Unit	NHX-125	Test method and other aspects
Hardness	HD-A	90	JIS K 7215
Tension test	Tensile strength	MPa	5.0
	Elongation	%	
After heat aging	Tensile strength	MPa	5.0 or more
	Elongation	%	
Dielectric strength	—	Non destructive	2,500 V × 1 minute
Cold bend	—	No crack	-30°C × 1 hour
Longitudinal change	—	Equivalent of VW-1	UL-224

* The data above are representative values and not guaranteed values.

* Recommended temperature range: -20°C to 125°C

Standard dimension chart					
Size	Inner diameter (mm)	Inner diameter tolerance (mm)	Wall thickness (mm)	Thickness tolerance (mm)	Unit length (m)
3 × 3.8	3.0	± 0.25	0.40	± 0.05	300
4 × 4.8	4.0				300
5 × 5.8	5.0	± 0.30			300
6 × 6.8	6.0				300
7 × 7.8	7.0	± 0.35			300
8 × 8.8	8.0		300		
9 × 10	9.0		200		
10 × 11	10.0	0.50	200		
11 × 12	11.0		200		
12 × 13.1	12.0	± 0.40	0.55	± 0.06	100
13 × 14.1	13.0				100
14 × 15.1	14.0				100
15 × 16.2	15.0	0.60	0.60	± 0.06	100
16 × 17.2	16.0				100
17 × 18.2	17.0				100
18 × 19.3	18.0	± 0.50	0.65	± 0.07	100
19 × 20.3	19.0				100
20 × 21.3	20.0				100

● Tubing with the inner diameter of 15ø or more are flattened and coiled.

● Black is the standard color of the tubing.

● We welcome inquiries on other colors, sizes, and tubing cut in different lengths.

EXLON-Flow-Link Tubing
NHX-125



Highly nonflammable



Flexibility



125°C level



Recyclability

EXLON-eco Series

EXLON-Flow-Link Tubing NHX-105

IWASE



Printing on the tubing **○ -F- IWASE NHX-105 F-LINK-NHX VW-1 E90287**



This is a completely new type of clean, highly non flammable, highly heat resistant, and flexible elastomer tubing with environmental conservation features.

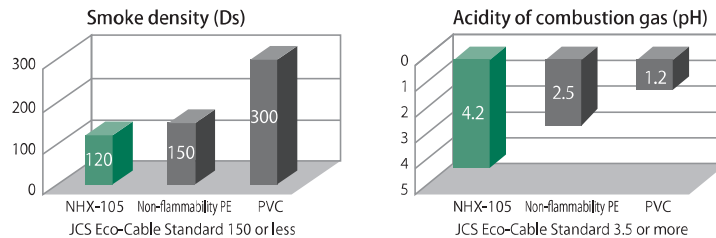

Highly nonflammable

High non-flammability

In compliance with the UL non-flammability standard VW-1 (UL File No./E90287)
In compliance with the -F- Mark of the Electrical Appliance and Material Safety Act
In compliance with Flammability Test for Railway Stock.



Flexibility

Flexibility

The same level of flexibility as flexible PVC tubing is achieved.



105°C level

105°C level

The polymer has a special cross-linked structure, which enables the heat resistance level of 105°C.



Low smoke emission

Low smoke emission

This tube has low smoke density and low acidity.
(See the graph above.)



Recyclability

Recyclability

Materials can be recycled like a general thermo plastics.

EXLON-Flow-Link Tubing NHX-105



Table of tubing characteristics			
Items	Unit	NHX-105	Test method and other aspects
Hardness	HD-A	88	JIS K 7215
Tension test	Tensile strength	MPa	5.0
	Elongation	%	
After heat aging	Tensile strength	MPa	5.0 or more
	Elongation	%	
Dielectric strength		—	Nondestructive
Cold bend		—	2,500 V × 1 minute
Non-flammability		—	No crack
		—	-30°C × 1 hour
		—	VW-1
		—	UL-224

* The data above are representative values and not guaranteed values.

* Recommended temperature range: -20°C to 105°C

Standard size chart					
Size	Inner diameter (mm)	Inner diameter tolerance (mm)	Wall thickness (mm)	Thickness tolerance (mm)	Unit length (m)
1 × 1.9	1.0	± 0.15	0.45	± 0.04	300
2 × 2.9	2.0				300
3 × 3.9	3.0	± 0.25	0.50	± 0.05	300
4 × 5	4.0				300
5 × 6	5.0	± 0.30	0.50	± 0.05	300
6 × 7	6.0				300
7 × 8	7.0	± 0.35	0.60	± 0.06	300
8 × 9	8.0				300
9 × 10	9.0	± 0.40	0.60	± 0.06	200
10 × 11.2	10.0				200
11 × 12.2	11.0	± 0.40	0.60	± 0.06	200
12 × 13.2	12.0				200
13 × 14.2	13.0	± 0.50	0.70	± 0.07	100
14 × 15.2	14.0				100
15 × 16.2	15.0	± 0.50	0.70	± 0.07	100
16 × 17.4	16.0				100
17 × 18.4	17.0	± 0.50	0.70	± 0.07	100
18 × 19.4	18.0				100
19 × 20.4	19.0	± 0.50	0.70	± 0.07	100
20 × 21.4	20.0				100

- Tubing with the inner diameter of 15ø or more are flattened and coiled.
- Black is the standard color of the tubing.
- We welcome inquiries on other colors, sizes, and tubing cut in different lengths.



EXLON-Flow-Link Tubing
NHX-105

Highly nonflammable

Flexibility

105°C level

Low smoke density

Recyclability

EXLON-eco Series

EXLON-Soft-Eco Tubing NHR-80

IWASE



Printing on the tubing ● IWASE EXLON-ソフトエコ NHR



Characteristics

Iwase's Soft-Eco Tubing NHR-80 does not contain any halogen compound or harmful substances in all materials that generate dioxins during combustion or environmental contamination after being landfilled.



Flexibility

Flexibility

The excellent flexibility is suitable for pipe arrangement or storage in narrow areas. This tubing is a suitable alternative to a flexible PVC tubing.



90°C level

90°C level

The heat resistance is at the 90°C level.



Recyclability

Recycling

Materials can be recycled like a general thermo plastics.



Self-extinguishing characteristics

Self-extinguishing characteristics

This tubing has self-extinguishing characteristics.

EXLON-Soft-Eco Tubing NHR-80



Table of tubing characteristics					
Items	Unit	Soft Eco NHR-80	EXLON-PVC J Tubing Black	Test method and other aspects	
Hardness	HD-A	85	85	JIS K 7215	
Tension test	Tensile strength	MPa	7.0 or more	15.0 or more	JIS C 2133
	Elongation	%	200 or more	200 or more	
After heat aging	Tensile strength retention rate	MPa	70 or more	—	JIS C 2133 121°C × 7 days
	Elongation retention rate	%	70 or more	—	
Dielectric strength	—	Nondestructive	Nondestructive	2,500 V × 1 minute	
Cold bend	—	No crack	No crack	-10°C × 1 hour	
Non-flammability (UL-94)	—	Equivalent of HB	Equivalent of HB	Sheet thickness: 1mm	

* The data above are representative values and not guaranteed values.

* Recommended temperature range: -20°C to 90°C

Standard size chart					
Size	Inner diameter (mm)	Inner diameter tolerance (mm)	Wall thickness (mm)	Thickness tolerance (mm)	Unit length (m)
3 × 3.8	3.0	± 0.25	0.40	± 0.05	300
4 × 4.8	4.0				300
5 × 5.8	5.0	± 0.30			300
6 × 6.8	6.0				300
7 × 7.9	7.0	± 0.35	0.45	± 0.05	300
8 × 8.9	8.0				300
9 × 9.9	9.0		200		
10 × 11	10.0	± 0.40	0.50	± 0.06	200
11 × 12	11.0				200
12 × 13	12.0		100		
13 × 14.1	13.0		0.55		± 0.06
14 × 15.1	14.0	100			
15 × 16.2	15.0	± 0.50	0.60	± 0.07	100
16 × 17.2	16.0				100
17 × 18.2	17.0		0.65		± 0.07
18 × 19.3	18.0	100			
19 × 20.3	19.0	100			
20 × 21.3	20.0				100

● Tubing with the inner diameter of 15ø or more are flattened and coiled. ● Black is the standard color of the tubing.

● We welcome inquiries on other colors, special sizes, and tubing cut in different lengths.

● Please contact us for details of the hardness. ● Tubing with the inner diameter from 3ø to 10ø are kept in stock.

EXLON-Soft-Eco Tubing
NHR-80

Flexibility

90°C level

Recyclability

Self-extinguishing characteristics

EXLON-eco Series

EXLON LINK Tubing

IWASE



Characteristics

These are cross-linked polyethylene tubing developed with Iwase's unique production technologies. LINK Tubing have the thermal deformation resistance that compares with products with radiation crosslinking while taking advantage of the excellent electric insulation performance of polyethylene.



Varnish
resistance

Varnish resistance

These tubing have excellent chemical resistance (such as against varnishing) to be used as lead wire protection tubing when varnishing is required.



Stress cracking
resistance

Stress cracking resistance

These tubing have excellent resistance against stress-induced fatigue fracture or cracks on materials in comparison to non-cross-linked polyethylene.



90°C level

90°C level

The heat resistance is at the 90°C level.

EXLON LINK Tubing



Tubing and materials property chart			
Items	Unit	Properties-value	Test method and other aspects
Tensile strength	MPa	10.4 or more	JIS C 2133
Elongation	%	200 or more	
After heat aging	Tensile strength retention rate	MPa	136°C × 168 hours
	Elongation retention rate	%	
Dielectric strength	—	Acceptable	2,500 V × 1 minute
Volume resistivity	Ω-cm	10 ¹⁰ or more	JIS C 2133

* The data above are representative values and not guaranteed values.

* Recommended temperature range: -30°C to 90°C

Standard size chart					
Size	Inner diameter (mm)	Inner diameter tolerance (mm)	Wall thickness (mm)	Thickness tolerance (mm)	Unit length (m)
4 × 4.6	4.0	+0.2, -0.15	0.3	± 0.05	400
5 × 5.6	5.0	+0.3, -0.2	0.3	± 0.05	300
6 × 6.6	6.0	+0.3, -0.2	0.3	± 0.05	300
7 × 7.6	7.0	+0.4, -0.2	0.3	± 0.05	300
8 × 8.8	8.0	+0.4, -0.2	0.4	+0.08, -0.05	200
9 × 9.8	9.0	+0.4, -0.2	0.4	+0.08, -0.05	200
10 × 10.8	10.0	+0.4, -0.2	0.4	+0.08, -0.05	200

● Black is the standard color of the tubing.

● Please contact us for other colors, special sizes, and tubing cut in different lengths.

EXLON
LINK Tubing



Varnish
resistance



Stress cracking
resistance



90°C level

EXLON-eco Series

EXLON Eco Clear Tubing

IWASE



Printing on the tubing ● IWASE EXLON-エコクリア



Characteristics

We achieved sufficient flexibility and transparency that could not be achieved in conventional elastomer tubing using Iwase's technologies for developing environmentally friendly elastomer tubing.



Transparency

Transparency

The clear transparency allows easy internal visual inspection that could not be done with conventional elastomer resin tubing.



Flexibility

Flexibility

The excellent flexibility is suitable for pipe arrangement in narrow areas and corners.



General type

Low temperature General type

This tubing has rubber-like elasticity and is also resistant to cold weather.

EXLON Eco Clear Tubing



Table of tubing characteristics			
Items	Unit	Eco Clear	Testing conditions and other aspects
Cold bend	°C	-30 or less	JIS C 2133
Tension test	Tensile strength	MPa	12
	Elongation	%	600 or more
After heat aging	Tensile strength	MPa	10 or more
	Elongation	%	500 or more
Relative density	—	0.90	JIS K 7112
Hardness (HD-A)	—	73	JIS K 7215

* The data above are representative values and not guaranteed values.

* Recommended temperature range: -20°C to 60°C

Standard size chart					
Size	Inner diameter (mm)	Inner diameter tolerance (mm)	Wall thickness (mm)	Thickness tolerance (mm)	Unit length (m)
4 × 4.6	4.0	± 0.25	0.30	± 0.04	300
5 × 5.6	5.0	± 0.25	0.30	± 0.04	300
6 × 6.7	6.0	± 0.30	0.35	± 0.04	300
7 × 7.7	7.0	± 0.30	0.35	± 0.04	300
8 × 8.8	8.0	± 0.30	0.40	± 0.04	200
9 × 9.8	9.0	± 0.35	0.40	± 0.05	200
10 × 10.9	10.0	± 0.35	0.45	± 0.05	100
12 × 13	12.0	± 0.35	0.50	± 0.05	100
14 × 15.1	14.0	± 0.35	0.55	± 0.05	100

- Transparent (natural) is the only color for this tubing.
- Please contact us for other special sizes, tubing cut in different lengths, and other conditions.

EXLON
Eco Clear Tubing



Transparency



Flexibility



Low temperature
General type

EXLON
Fluoro Resin
Series

PFA Tubing

PFA Micro-Fluoro Resin Tubing

PFA FLEXIBLE Tubing

PFA COIL Tubing

THV Soft Fluoro Resin Tubing

EXLON Fluoro Resin Series

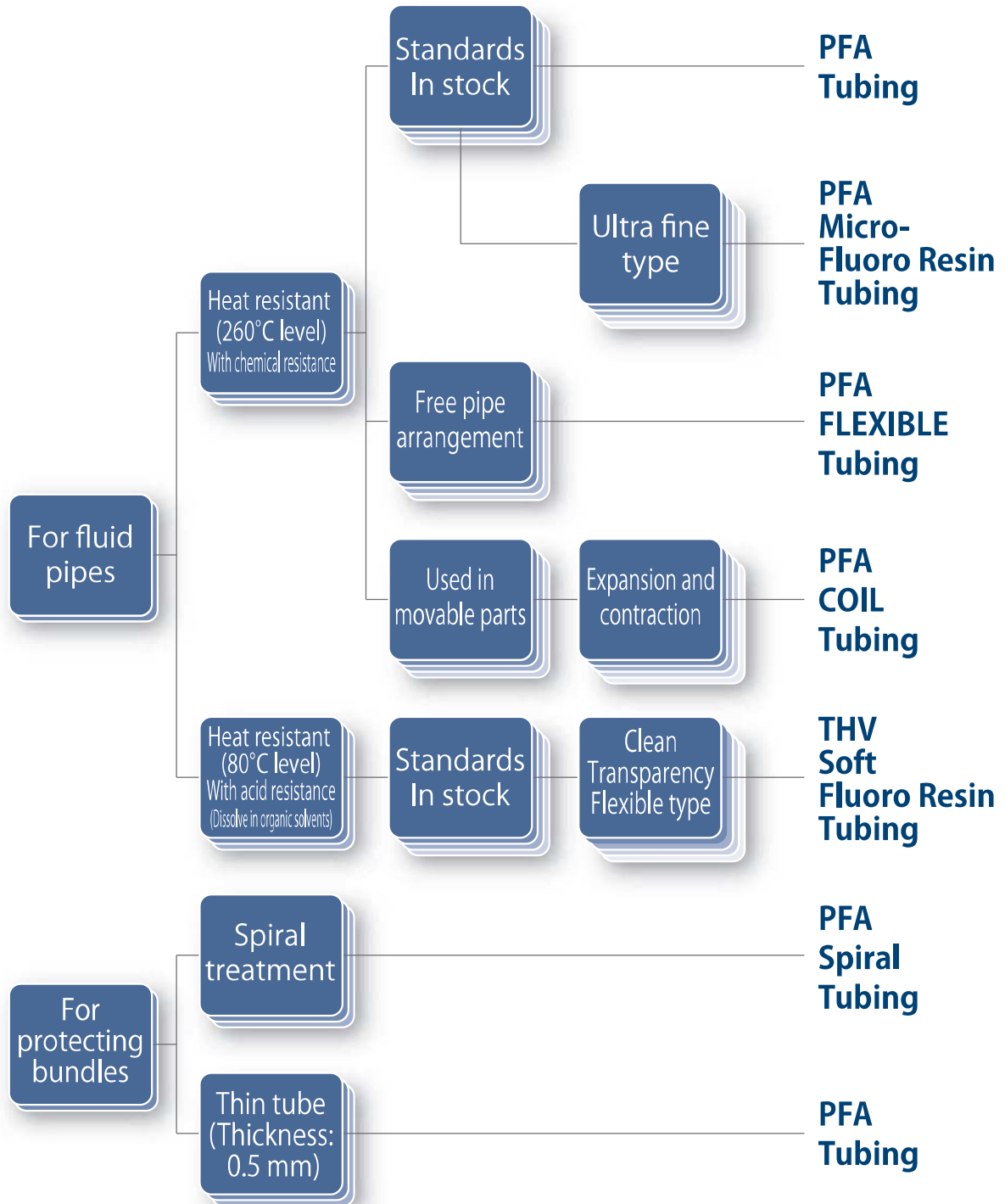

EXLON PFA Tubing



These tubing have excellent heat resistance, chemical resistance, weather resistance, non-cohesiveness, and electric insulation. These tubing can be used for a variety of purposes, including semiconductor production devices, chemical plants, physiochemical devices, food manufacturing equipment, and medical devices.



Weather
resistant

Highly heat resistant

These tubing are made of PFA resin with the heat resistance which allows continuous uses up to 260°C.



Chemical
resistance

Chemical resistance

These tubing are resistant to and inactive against most chemicals and solvents.



Weather
resistant

Weather resistant

They have properties that resist age-dependent changes and deteriorations in harsh outdoor environments.



Non-cohesive
property

Non-cohesive property

These tubing do not adhere on sticky objects and can be easily peeled off.



Electric
insulation

Electric insulation

These tubing have excellent electrical properties and the highest insulation resistance in plastic.

EXLON PFA Tubing



Standard size chart							
Size (Outer diameter × Inner diameter)	Dimension tolerance (mm)		Unit length (m)				
	Outer diameter	Thickness	2 straight	10	20	50	100
3 × 2	±0.1	±0.08		●	●		●
4 × 2	±0.1	±0.08		●	●	●	●
4 × 2.5	±0.1	±0.08		●	●		
4 × 3	±0.1	±0.08		●			●
5 × 4	±0.1	±0.08		●			●
6 × 4	±0.1	±0.08		●	●	●	●
6 × 5	±0.1	±0.08		●			●
7 × 6	±0.1	±0.08		●			●
8 × 6	±0.1	±0.08		●	●	●	●
8 × 7	±0.1	±0.08		●			
9 × 8	±0.1	±0.08		●			●
10 × 8	±0.1	±0.08		●	●	●	●
10 × 9	±0.1	±0.08		●			
12 × 9	±0.1	±0.08		●			
12 × 10	±0.1	±0.08		●	●	●	●
16 × 13	±0.1	±0.08		●			
16 × 14	±0.1	±0.08		●			
18 × 16	±0.1	±0.08		●			
19 × 16	±0.1	±0.08		●			
3.17 × 1.59	±0.1	±0.08		●			
6.35 × 3.96	±0.1	±0.08		●			
6.35 × 4.35	±0.1	±0.08	●	●	●	●	●
9.53 × 6.35	±0.1	±0.08	●	●	●	●	●
9.53 × 7.53	±0.1	±0.08		●			
12.7 × 9.53	±0.1	±0.08	●	●	●	●	●
12.7 × 10.7	±0.1	±0.08	●	●			
19.05 × 15.88	±0.1	±0.08	●	●	●	●	●
25.4 × 22.26	±0.15	±0.08	●	●	●	●	●

Ones marked with "●" means they are in stock.

- Availability of inventory may change, because they are based on the production at this point.
- Other sizes and lengths besides the standard lengths can be produced. Please contact us for details.



EXLON PFA Tubing

Highly heat resistant

Chemical resistance

Weather resistant

Non-cohesive property

Electric insulation

EXLON PFA Micro-Fluoro Resin Tubing

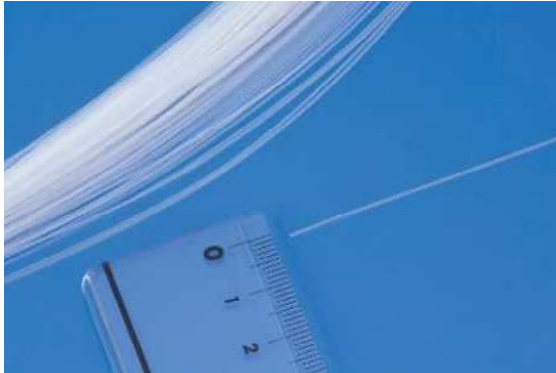

Characteristics

These are extra fine tubing made with the same performance as PFA tubing. These tubing can be used for protecting fine wires exposed to the environment where heat resistance and chemical resistance are required and for wiring of biomedical devices and analytical devices.



Ultra fine

Ultra fine

Sizes with the inner diameter from $\varnothing 0.1$ to $\varnothing 0.5$ are available. These are super extra fine PFA tubing suitable for purposes where advanced precision is required.



Highly heat resistant

Highly heat resistant

These tubing are made of PFA resin with the heat resistance which allows continuous uses up to 260°C .



Chemical resistance

Chemical resistance

These tubing are resistant to and inactive against most chemicals and solvents.

EXLON PFA Micro-Fluoro Resin Tubing



Standard size chart				
Size (Inner diameter × Outer diameter)	Wall thickness (mm)	Dimension tolerance		Standard length (m)
		Inner diameter (mm)	Thickness (mm)	
0.1 × 0.3	0.1	± 0.03	± 0.03	100
0.2 × 0.4	0.1	± 0.03	± 0.03	100
0.3 × 0.5	0.1	± 0.03	± 0.03	100
0.4 × 0.6	0.1	± 0.04	± 0.03	100
0.5 × 0.7	0.1	± 0.05	± 0.03	100

● Other sizes and lengths besides the standard lengths can be produced. Please contact us for details.

EXLON
PFA Micro-Fluoro Resin Tubing



Ultra fine



Highly heat resistant



Chemical resistance

EXLON-Fluoro Resin Series

EXLON PFA FLEXIBLE Tubing

IWASE



Characteristics

Corrugated shapes are created on PFA tubing. The spiral shape of this product prevents getting bent or flattened when folded. These tubing are suitable for wiring in the transportation of chemicals, solvents, and gases, as well as analytical devices and semiconductor devices.



Free pipe arrangement

Free pipe arrangement

The spiral shapes make the bend radius smaller compared to tubings without spiral shapes.



Highly heat resistant

Highly heat resistant

These tubing are made of PFA resin with the heat resistance that allows continuous use up to 260°C.



Chemical resistance

Chemical resistance

These tubing are resistant to and inactive against most chemicals and solvents.

EXLON PFA FLEXIBLE Tubing

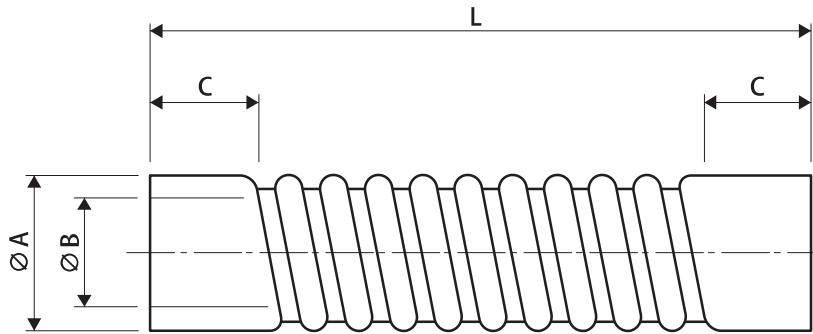

ØA : Outer diameter
 ØB : Inner diameter
 C : Straight section
 L : Total length

Standard size chart			
Size (ØA × ØB)	Wall thickness (mm)	Straight section C (mm)	Total length L (mm)
5 × 4	0.5	30	300 500 1000 1500 2000
6 × 4	1		
6 × 5	0.5		
7 × 6	0.5		
8 × 6	1		
8 × 7	0.5		
9 × 8	0.5		
10 × 8	1		
10 × 9	0.5		
11 × 10	0.5		
12 × 10	1		
14 × 12	1		
16 × 14	1		
18 × 16	1		
19 × 16	1.5		
6.35 × 4.35	1		
9.53 × 7.53	1		
12.7 × 10.7	1		
12.7 × 9.53	1.585		
19.05 × 15.88	1.585		
25.4 × 22.26	1.57		

- The total lengths can be extended from 100 L to 2000 L depending on tubing sizes.
The standard length at the straight section (C) at both ends is 30L, but we can produce tubing with other lengths.
- We receive orders starting with a single tubing.
- We can produce tubing with other sizes. Please contact us for details.



EXLON
PFA FLEXIBLE Tubing



Free pipe arrangement



Highly heat resistant



Chemical resistance

EXLON-Fluoro Resin Series

EXLON PFA COIL Tubing

IWASE



PFA tubing are curved and formed in a coil shape. These tubing are suitable for pipe arrangements in moving parts of devices and pipe arrangements with undetermined distances.



Expansion and
contraction

Expansion and contraction

The coil shape enables these tubing to be used in moving parts where expansion and contraction are required.



Highly heat
resistant

Highly heat resistant

These tubing are made of PFA resin with the heat resistance which allows continuous uses up to 260°C.



Chemical
resistance

Chemical resistance

These tubing are resistant to and inactive against most chemicals and solvents.

EXLON PFA COIL Tubing

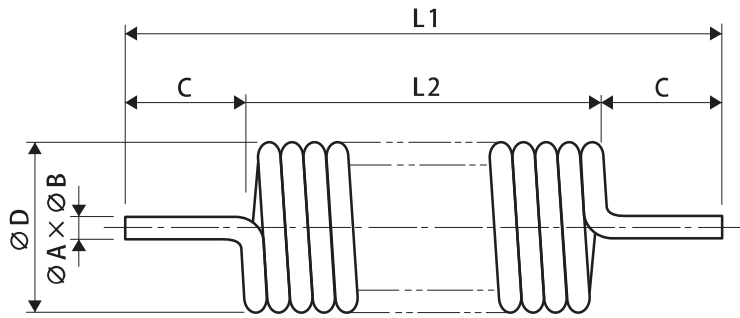

$\varnothing A \times \varnothing B$: Outer diameter \times Inner diameter
 C : Straight section
 $\varnothing D$: Outer diameter of the coil
 L1 : Total length of the coil
 L2 : Length of the bonded section of the coil

Standard Size						
Size ($\varnothing A \times \varnothing B$)	Straight section (C)	Outer diameter of the coil ($\varnothing D$)	Total length of the coil (L1)	Length of the bonded coil (L2)	Number of winding	Range of stretching section (mm)
4 × 2	100	30	300	100	20	400
6 × 4	100	40	350	150	20	500
8 × 6	100	60	400	200	20	600
10 × 8	100	80	450	250	20	800
12 × 10	100	150	500	300	20	1,000
3.17 × 1.59	100	30	300	100	20	400
6.35 × 4.35	100	40	350	150	20	500
9.53 × 7.53	100	80	450	250	20	800
12.7 × 10.7	100	150	500	300	20	1,000

- The standard length of the straight section at both ends is 100L, but we can produce other lengths.
- We receive orders starting with a single tubing.
- We can produce tubing with other sizes. Please contact us for details.
- The coiling work results in 15% to 20% flatness on the contour of the tubing.



EXLON PFA COIL Tubing



Expansion and contraction



Highly heat resistant



Chemical resistance

EXLON THV Soft Fluoro Resin Tubing

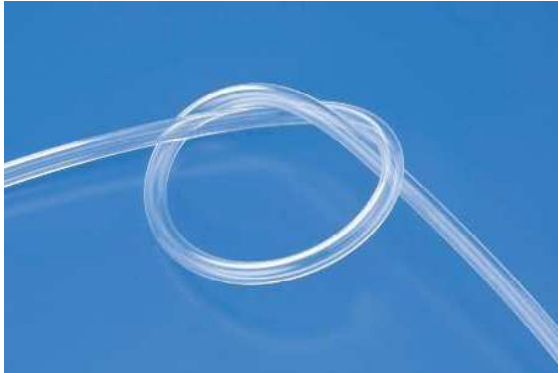

THV Flexible Fluoro Resin Tubing is the thermoplasticity fluoroethylene resin consisting of three types of monomers including tetrafluoroethylene (TFE), hexafluoropropylene (HFP), and vinylidene difluoride (Vdf).

This flexible fluoro resin tubing has excellent transparency despite being made of fluoroethylene resin and drastically improved flexibility.



Transparency

Transparency

This product has excellent transparency because of the amorphous property. A wide range of light from the ultraviolet region to the infrared region can permeate through this product.



Flexibility

Flexibility

This product has especially great flexibility compared to conventional fluoro resin and allows pipe arrangement in narrow areas and moving parts without modifying it.



Clean

Clean

There is little elution of additives from this product because of the use of fluoro resin with flexibility created by adjusting the amounts of three types of monomers.

EXLON THV Soft Fluoro Resin Tubing



Standard Size				
Size (Outer diameter × Inner diameter)	Wall thickness (mm)	Dimension tolerance		Unit length (m)
		Outer diameter (mm)	Thickness (mm)	
4 × 2	1.0	± 0.1	± 0.05	10
6 × 4	1.0	± 0.1	± 0.05	10
8 × 6	1.0	± 0.1	± 0.05	10
10 × 8	1.0	± 0.15	± 0.05	10
12 × 10	1.0	± 0.15	± 0.05	10

● We can produce tubing with other sizes. Please contact us for details.



EXLON
THV Soft Fluoro Resin Tubing



Transparency



Flexibility



Clean

Modified PFA Tubing Lineup



EXLON-Fluoro Resin is modified into secondary products using thermal processing.



Spiral cut



Flare



Bend



Tapered



Sealed tip

Other types of modified tubing can be produced in small lots. Please contact us for details.

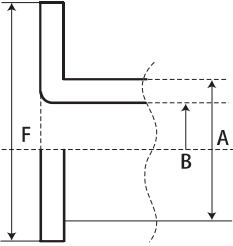
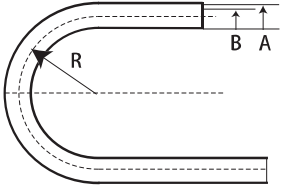

PFA Tubing dimension chart for available processing (mm)

Outer diameter × Inner diameter (A × B)	 Flare	 Bend
	Maximum outer diameter [F]	Minimum radius [R]
4 × 2	—	10
6 × 4	8	10
8 × 6	12	15
10 × 8	16	20
12 × 10	20	25
14 × 12	24	35
16 × 14	28	40
18 × 16	32	60
20 × 18	36	80
23 × 20	40	100
3.17 × 1.59	—	10
6.35 × 3.96	8	10
9.53 × 6.35	13	15
12.7 × 9.53	20	25
19.05 × 15.88	32	60
25.4 × 22.26	46	100

● The data above are representative values and not guaranteed values.

EXLON-PFA Tubing data

Burst pressure

Size (mm)	Burst pressure (MPa)	Size (mm)	Burst pressure (MPa)	Size (mm)	Burst pressure (MPa)
3 × 2	6.3	9 × 8	1.8	3.17 × 1.59	10.3
4 × 2	10.5	10 × 8	3.5	6.35 × 3.96	7.3
4 × 2.5	7.3	10 × 9	1.6	6.35 × 4.35	5.9
4 × 3	4.5	12 × 9	4.5	9.53 × 6.35	6.3
5 × 4	3.5	12 × 10	2.8	9.53 × 7.53	3.7
6 × 4	6.3	16 × 13	3.3	12.7 × 9.53	4.5
6 × 5	2.9	16 × 14	2.1	12.7 × 10.7	2.7
7 × 6	2.4	18 × 16	1.8	19.05 × 15.88	2.8
8 × 6	4.5	19 × 16	2.7	25.4 × 22.26	1.8
8 × 7	2.1	22 × 20	1.5		

- These data are based on the room temperature at 25°C.
- The burst pressure decreases as the operating temperature increases.
- The recommended designed pressure for actual operation (safety pressure) can be obtained by using the safety factor of 3.5 or more for the above burst pressure.
- These data are representative values and not guaranteed values.

$$\text{Designed pressure for actual operation} = \frac{\text{Burst pressure}}{\text{Safety factor } (\geq 3.5)}$$

Changes in the burst pressure based on temperature (Size 6Ø × 4Ø)

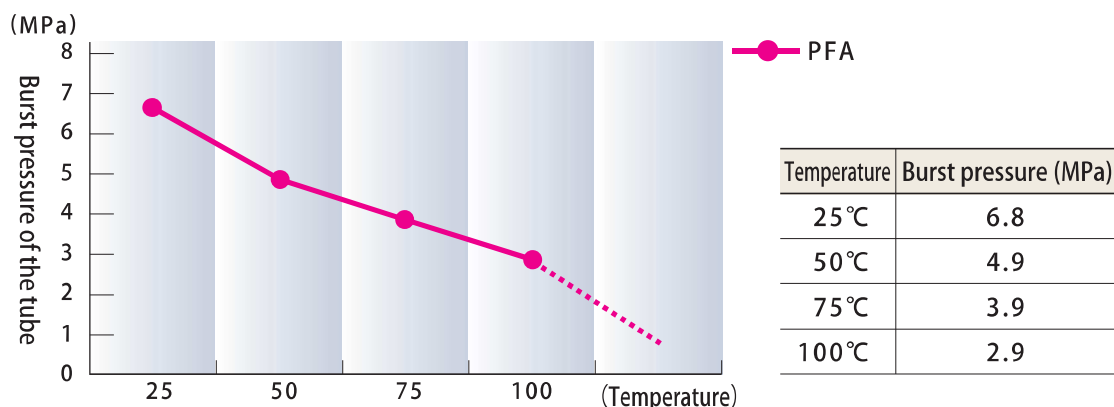

- The data above are representative values and not guaranteed values.

Minimum bend radius

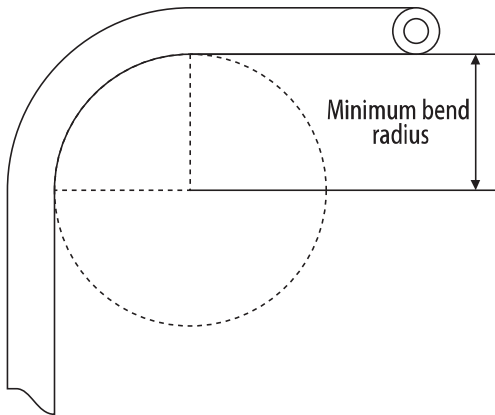

Size (mm)	Minimum bend radius (mm)
4 × 2	10
6 × 4	20
8 × 6	30
10 × 8	65
12 × 10	90
6.35 × 3.96	15
9.53 × 6.35	50
12.7 × 9.53	75

● The data above are representative values and not guaranteed values.

EXLON-THV Flexible Fluoro Resin Tubing data

Burst pressure

Size Outer diameter × Inner diameter (mm)	Burst pressure (MPa)	Normal pressure (MPa)
4 × 2	4.4	1.0
6 × 4	2.9	0.6
8 × 6	2.1	0.4
10 × 8	1.6	0.35
12 × 10	1.3	0.3

- The burst pressure above is the data obtained when the ambient temperature is 20°C. Please note that the burst pressure changes with temperature. The setup is based on Normal pressure \doteq (Burst pressure)/4.
- The data above are representative values and not guaranteed values.

Minimum bend radius

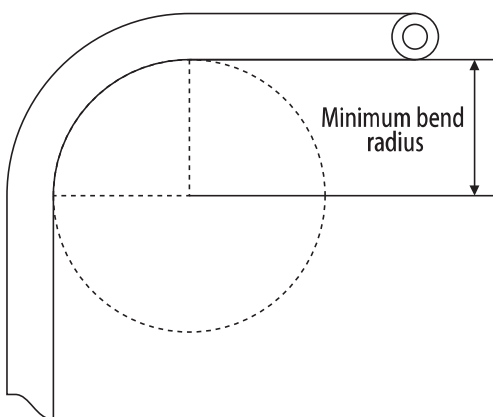

Outer diameter × Inner diameter (mm)	Minimum bend radius (mm)
4 × 2	3
6 × 4	10
8 × 6	20
10 × 8	35
12 × 10	45

- The data above are representative values and not guaranteed values.



Chemical resistance data

Test condition 23°C, 1000 hours	
Coefficient of cubic expansion (%)ASTM D792	
Chemical	Ratio of changes in cubic expansion (%)
Acetone*	Dissolved
Hexane	2.0
MEK*	Dissolved
Acetic acid	24.6
Aniline	1.7
Benzene	5.6
Ethanol	2.0
Chlorobenzene	2.6
Dichloromethane	9.9
Ethyl ether	17.2
Formaldehyde	2.1
Nitrobenzene	6.1
n-Propylamine*	Dissolved
N-Methyl-2-pyrrolidine*	Dissolved

* Reaction with THV occurs, and THV dissolves.

● These data are based on experiments that we trust, but we cannot guarantee the accuracy and perfectness of these experiments.

Characteristics of fluoro resin



Comparison chart of fluoro resin properties								
Category	Unit	ASTM testing method	PFA	FEP	ETFE	PVdf	PTFE	
Physical	Relative density	—	D792	2.12~2.17	2.12~2.17	1.70~1.76	1.78	2.14~2.20
	Melting point	°C	—	302~310	253~282	260~270	140~145	320~330
Mechanical	Tensile strength	MPa	D638	24~41	19~22	40~44	20~34	27~34
	Elongation	%	D638	280~300	250~330	400~440	100~300	200~400
	Compression strength	MPa	D695	17	15	49	40~55	12
	Tensile elasticity	MPa	D638	—	343	490~784	784~1,960	392
	Bending elasticity	MPa	D790	647~686	539~637	882~1,372	1,372~1,764	490~588
	Impact strength (izot)	J/m	D256	No destruction	No destruction	No destruction	160~370	160
	Hardness	Rockwell	D785	—	—	R50	—	—
	Hardness	Durometer	D1706	D60	D55	D75	D65~70	D50~65
	Coefficient of dynamic friction	0.7MPa3m/min	—	0.2	0.3	0.4	0.39	0.1
	Thermal	Thermal conductivity	W/m/k	C177	0.25	0.25	0.24	0.10~0.13
Specific heat		10 ³ J/kg/k	D240	1.0	1.2	1.9~2.0	1.4	1.0
Coefficient of linear expansion		10 ⁻⁵ /°k	D696	12	8.3~10.5	5.9	7~14	10
Critical temperature		°C	—	260	200	150	125	260
Deflection 0.45MPa Temperature		°C	D648	74	72	104	149	121
Load 1.8MPa		°C	D648	50	50	74	87~120	55
Electrical	Electrical resistivity	Ω·cm	D257	>10 ¹⁸	>10 ¹⁸	>10 ¹⁶	2×10 ¹⁴	>10 ¹⁸
	Breakdown strength	KV/mm (thickness 3.2mm)	D149	20	20~24	16	10	19
	Conductivity 60 Hz	—	D150	<2.1	2.1	2.6	8.4	<2.1
	Conductivity 10 ³ Hz	—	D150	<2.1	2.1	2.6	8.4	<2.1
	Conductivity 10 ⁶ Hz	—	D150	<2.1	2.1	2.6	6.4	<2.1
	Dielectric dissipation factor 60 Hz	—	D150	<0.0002	<0.0002	0.0006	0.05	<0.0002
	Dielectric dissipation factor 10 ³ Hz	—	D150	<0.0002	<0.0002	0.0008	0.02	<0.0002
	Dielectric dissipation factor 10 ⁶ Hz	—	D150	<0.0003	<0.0005	0.005	<0.015	<0.0002
	Arc resistance	sec	D495	>300	>300	75	50~70	>300
	Chemical resistance	—	D543	Excellent	Excellent	Good	Acceptable	Good
	Non-flammability	—	D635	Non-inflammability	Non-inflammability	Flame retardance	Flame retardance	Non-inflammability
	Water absorption(24hr)	%	D570	<0.01	<0.01	0.03	0.05	<0.01

● The data above are representative values and not guaranteed values.



Chemical resistance

■ Acid

Product name	PFA		FEP		ETFE		PVdf	
	23	100	23	100	23	100	23	100
Acetic acid 50%	○	○	○	○	○	○	○	○
Glacial acetic acid	○	○	○	○	○	○	○	×
Benzoic acid	○	○	○	○	○	△	○	○
Benzene sulfonic acid	○	○	○	○	○	○	○	×
Chlorosulfuric acid	○	○	○	○	△	△	×	×
Chromic acid 50%	○	○	○	○	△	△	○	△
Citric acid	○	○	○	○	○	○	○	○
Formic acid	○	○	○	○	○	△	○	○
Hydrogen bromide	○	○	○	○	○	○	○	○
Hydrochloric acid 10%	○	○	○	○	○	○	○	○
Hydrochloric acid 70%	○	○	○	○	○	○	○	○
Hydrofluoric acid 30%	○	○	○	○	○	△	○	○
Hydrofluoric acid 70%	○	○	○	○	○	△	○	○
Nitric acid 10%	○	○	○	○	○	△	○	○
Nitric acid 50%	○	○	○	○	○	△	○	×
Fuming nitric acid	○	○	○	○	○	△	×	×
Oxalic acid	○	○	○	○	○	○	○	×
Phenol 10%	○	○	○	○	○	○	○	○
Phenol 100%	○	○	○	○	○	△	○	×
Phthalic acid	○	○	○	○	○	○	○	○
Phosphoric acid 30%	○	○	○	○	○	○	○	○
Phosphoric acid 85%	○	○	○	○	○	△	○	○
Succinic acid	○	○	○	○	○	○	○	○
Sulfuric acid 50%	○	○	○	○	○	○	○	○
Sulfuric acid 85%	○	○	○	○	○	○	○	○
Sulfuric acid 95%	○	○	○	○	○	○	○	×
Fuming sulfuric acid	○	○	○	○	○	○	×	×

○ ... Usable

△ ... Test is necessary.

× ... Cannot be used

■ Base

Product name	PFA		FEP		ETFE		PVdf	
	23	100	23	100	23	100	23	100
Ammonium hydroxide 30%	○	○	○	○	○	○	○	○
Aniline	○	○	○	○	○	○	○	×
Barium hydroxide	○	○	○	○	○	○	○	○
Calcium hydroxide	○	○	○	○	○	○	○	○
Hexamethylenediamine	○	○	○	○	△	△	×	×
Magnesium hydroxide	○	○	○	○	○	○	○	○
Propylamine	○	○	○	○	△	△	×	×
Sodium carbonate	○	○	○	○	○	○	○	○
Sodium hydroxide 10%	○	○	○	○	○	○	○	△
Sodium hydroxide 50%	○	○	○	○	○	○	○	×

■ Oxidizing agent

Product name	PFA		FEP		ETFE		PVdf	
	23	100	23	100	23	100	23	100
Sulfur dioxide	○	○	○	○	○	○	○	△
Hydrogen peroxide 30%	○	○	○	○	△	△	○	○
Chlorine dioxide 10%	○	○	○	○	○	○	○	○
Nitrogen dioxide	○	○	○	○	○	○	○	△
Ozone	○	○	○	○	○	○	○	○
Potassium chlorate	○	○	○	○	△	△	○	○
Potassium permanganate	○	○	○	○	△	△	○	○
Sodium hypochlorite	○	○	○	○	○	○	○	○
Benzoyl peroxide	○	○	○	○	○	○	○	△

■ Aromatic hydrocarbon

Product name	PFA		FEP		ETFE		PVdf	
	23	100	23	100	23	100	23	100
Benzene	○	○	○	○	○	○	○	△
Naphthalene	○	○	○	○	○	○	○	○
Toluene	○	○	○	○	○	○	○	○

■ Halogenated hydrocarbon

Product name	PFA		FEP		ETFE		PVdf	
	23	100	23	100	23	100	23	100
Alkali chloride	○	○	○	○	○	○	○	○
Carbon tetrachloride	○	○	○	○	○	△	○	○
Chlorinated benzene	○	○	○	○	○	△	○	△
Chloroform	○	○	○	○	○	△	○	○
Ethylene dichloride	○	○	○	○	○	○	○	○
Ethylene bromide	○	○	○	○	○	○	○	○
Freon R-113 (coolant)	○	○	○	○	○	△	○	○

■ Ether/Ketone

Product name	PFA		FEP		ETFE		PVdf	
	23	100	23	100	23	100	23	100
Acetone 10%	○	○	○	○	○	○	○	×
Acetone 100%	○	○	○	○	○	○	×	×
Acetophenone	○	○	○	○	○	○	×	×
Dimethylformamide	○	○	○	○	○	○	×	×
Ethyl ether	○	○	○	○	×	×	○	×
Ethyl acetate	○	○	○	○	○	○	×	×
Ethylene oxide	○	○	○	○	○	○	○	○
Ethylene glycol	○	○	○	○	○	○	○	○
Glycerine	○	○	○	○	○	○	○	○
Methyl Cellosolve	○	○	○	○	○	○	○	○
Methyl ethyl ketone	○	○	○	○	○	○	×	×
Trimethyl phosphate	○	○	○	○	○	○	×	×

■ Gas

Product name	PFA		FEP		ETFE		PVdf	
	23	100	23	100	23	100	23	100
Ammonia anhydrous	○	○	○	○	○	○	×	×
Carbon dioxide	○	○	○	○	○	○	○	○
Hydrogen	○	○	○	○	○	○	○	○
Methane	○	○	○	○	○	○	○	○
Hydrogen sulfide	○	○	○	○	○	○	○	○

● The data above are representative values and not guaranteed values.

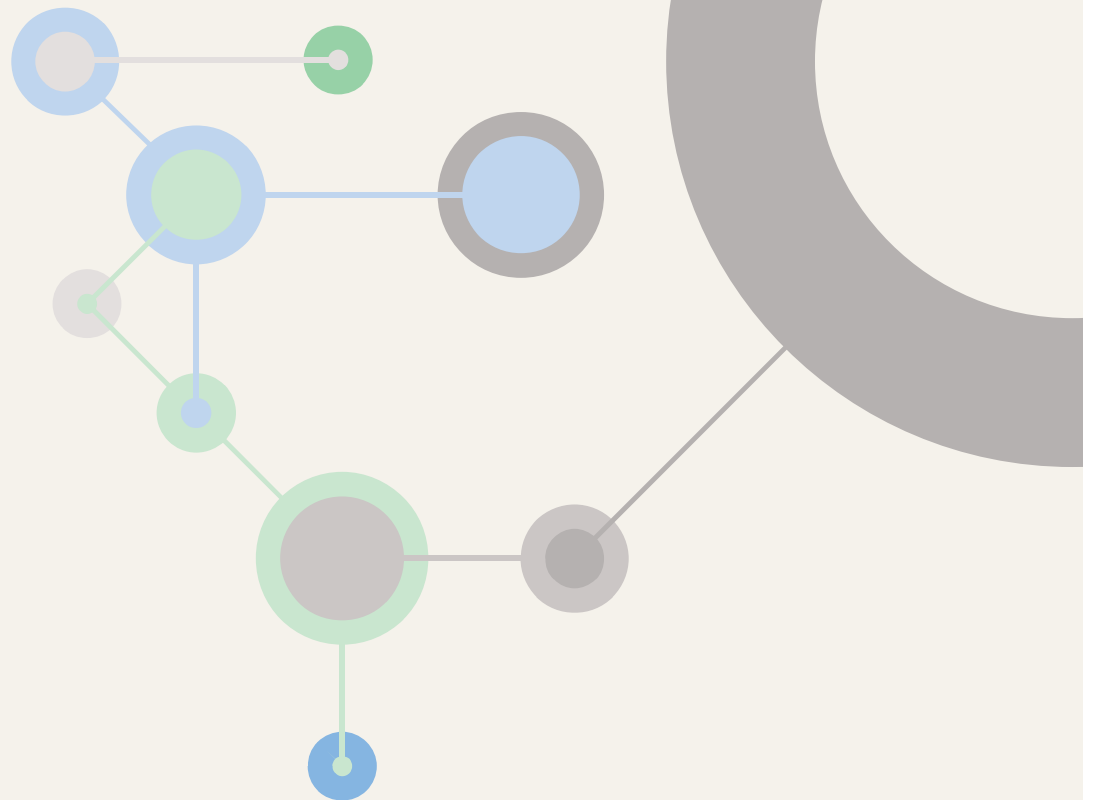

IWASE

IWASE Co., Ltd.

2-2-38 Shimotsuruma, Yamato-shi, Kanagawa 242-0001 Japan

TEL +81-46 (200) 6511

FAX +81-46 (200) 6512

<http://www.iwase.co.jp>